

# P1110B

## 915 MHz RF Powerharvester® Receiver User Manual



### DESCRIPTION

The Powercast P1110B Powerharvester® receiver is an RF energy harvesting device that converts RF to DC. Housed in a compact SMD package, the P1110B receiver provides RF energy harvesting and power management for battery and capacitor recharging. The P1110B converts RF energy to DC and provides the energy to the attached storage element. When an adjustable voltage threshold on the storage element is achieved, the P1110B automatically disables charging. A microprocessor can be used to obtain data from the component for improving overall system operation.

### FEATURES

- High conversion efficiency, >70%
- Low power consumption
- Configurable voltage output to support Li-ion and Alkaline battery recharging
- Operation from 0V to support capacitor charging
- Received signal strength indicator
- No external RF components required- Internally matched to 50 ohms
- Wide operating range
- Operating down to -5 dBm input power
- Industrial temperature range
- RoHS Compliant

### APPLICATIONS

- Wireless Sensors
  - Industrial Monitoring
  - Smart Grid
  - Structural Health Monitoring
  - Defense
  - Building automation
  - Agriculture
  - Oil & Gas
  - Location-aware services
- Wireless trigger
- Low power electronics

### FUNCTIONAL BLOCK DIAGRAM

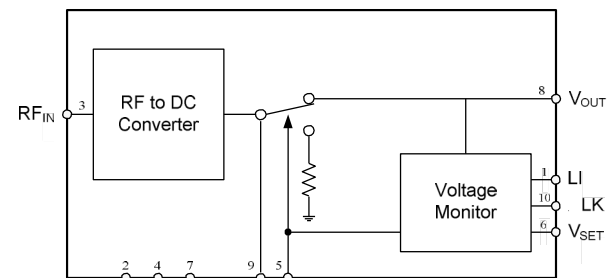

### PINOUT CONFIGURATION

TOP VIEW

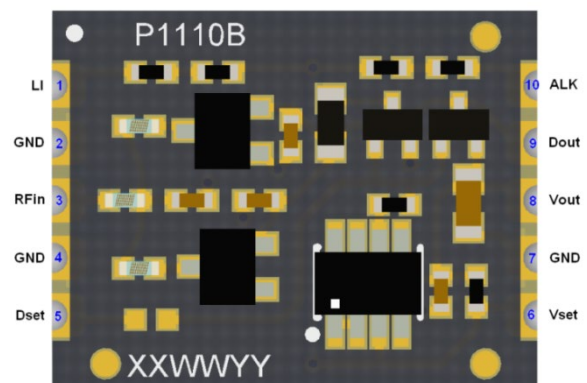

Powercast products and technology are covered by one or more patents with other patents pending. All patent and trademark information can be found at <http://www.powercastco.com/IP/>.

# P1110B

## 915 MHz RF Powerharvester® Receiver User Manual



### ABSOLUTE MAXIMUM RATINGS

T<sub>A</sub> = 25°C, unless otherwise noted.

Parameter	Rating	Unit
RF Input Power	23	dBm
RF <sub>IN</sub> to GND	0	V
D <sub>SET</sub> to GND	6	V
V <sub>OUT</sub> to GND	4.3	V
V <sub>OUT</sub> Current	100	mA
Operating Temperature Range	-40 to 85	°C
Storage Temperature Range	-40 to 85	°C



Exceeding the absolute maximum ratings may cause permanent damage to the device.

### ESD CAUTION

This is an ESD (electrostatic discharge) sensitive device. Proper ESD precautions should be taken to avoid degradation or damage to the component.



### PIN FUNCTIONAL DESCRIPTION

Pin	Label	Function
1	LI	Li-ion/LiPo recharging pin. Connect directly to the analog ground plane for 4.2V maximum recharging. NC when using ALK or V <sub>SET</sub> pin.
2	GND	RF Ground. Connect to analog ground plane.
3	RF <sub>IN</sub>	RF Input. Connect to 50Ω antenna through a 50Ω transmission line. Add a DC block if antenna is a DC short.
4	GND	RF Ground. Connect to analog ground plane.
5	D <sub>SET</sub>	Digital Input. Set to enable measurement of harvested power. If this function is not desired leave NC.
6	V <sub>SET</sub>	Maximum Output Voltage Adjustment. Sets the maximum output voltage on the V <sub>OUT</sub> pin. Connect to an external resistor. NC when using LI or ALK pin.
7	GND	DC Ground. Connect to analog ground plane.
8	V <sub>OUT</sub>	DC Output. Connect to external storage device. Maximum output voltage set by V <sub>SET</sub> , LI, or ALK pin.
9	D <sub>OUT</sub>	Analog Output. Provides an analog voltage level corresponding to the harvested power.
10	ALK	Alkaline recharging pin. Connect directly to the analog ground plane for 3.3V maximum recharging. NC when using LI or V <sub>SET</sub> pin.

### SPECIFICATIONS

T<sub>A</sub> = 25°C, V<sub>OUT</sub> = 3.0V, unless otherwise noted

Parameter	Symbol	Condition	Min	Typ	Max	Unit
RF Characteristics						
Input Power	RF <sub>IN</sub>		0		20	dBm
Frequency			902		928	MHz
DC Characteristics						
Output Voltage	V <sub>OUT</sub>		0		4.2	V
Output Current	I <sub>OUT</sub>				50	mA
Output Current	I <sub>OUT</sub>	No RF <sub>IN</sub>		-1.5		μA
V <sub>SET</sub> Range	V <sub>SET</sub>		1.8		4.2	V
Signal Strength	D <sub>OUT</sub>	RF <sub>IN</sub> = 0dBm		61		mV
Digital Characteristics						
D <sub>SET</sub> Input High				1		V
Timing Characteristics						
D <sub>SET</sub> Delay				20		μs

### FUNCTIONAL DESCRIPTION

#### RF Input (RF<sub>IN</sub>)

The RF input is an unbalanced input from the antenna. Any standard or custom 50Ω antenna may be used with the receiver. The P1110B has been optimized for operation in the 902-928MHz band but will operate outside this band with reduced efficiency. Contact Powercast for custom frequency requirements.

The RF input must be isolated from ground. For antennas that are a DC short, a high-Q DC blocking capacitor should be added in series with the antenna.

#### STORAGE SELECTION (V<sub>OUT</sub>)

The P1110B is designed to charge an external storage element including batteries and capacitors. The output voltage from the P1110B will be set by the voltage of the storage element with a maximum set by the V<sub>SET</sub>, LI, or ALK pin. The P1110B will produce a charging current that will be dependent on the RF input power.

The voltage on this pin can vary from 0V to 4.2V. The charging current for a fixed input RF power will decrease as the voltage on the V<sub>OUT</sub> pin increase due to the fixed amount of power available.

The P1110B monitors the voltage on the storage element and turns off V<sub>OUT</sub> when the element is fully charged. The P1110B does not monitor the charging current because it is typically much less than the maximum charge current of the storage element.

When selecting a storage element, the leakage current must be strongly considered. Certain battery chemistries have higher leakage currents than others. It is recommended that the leakage current of the storage element be less than 1% per month. Higher leakage currents will result in using more of the harvested energy to replace the capacity lost due to leakage rather than replenishing the capacity.

When no load is attached to the P1110B, a minimum of 10uF is required on the V<sub>OUT</sub> pin.

### RSSI OPERATION (D<sub>OUT</sub>, D<sub>SET</sub>)

The RSSI functionality allows the sampling of the received signal to provide an indication of the amount of energy being harvested. When D<sub>SET</sub> is driven high the harvested DC power will be directed to an internal sense resistor, and the corresponding voltage will be provided to the D<sub>OUT</sub> pin. The voltage on the D<sub>OUT</sub> pin can be read after a 20µs settling time.

When the RSSI functionality is being used, the harvested DC power is not being stored.

If the RSSI functionality is not used, the D<sub>OUT</sub> and D<sub>SET</sub> pins should be left as no connects. The D<sub>SET</sub> pin has an internal pull down.

### SETTING THE OUTPUT VOLTAGE (V<sub>OUT</sub>)

The maximum voltage from the P1110B is set using the V<sub>SET</sub>, LI, or ALK pin. The LI pin can be directly connected to ground to set the maximum voltage to 4.2V, or the ALK

pin can be directly connected to ground to set the maximum voltage to 3.3V. For custom voltage settings, the V<sub>SET</sub> pin can be used. Placing a resistor from V<sub>SET</sub> to ground will adjust the maximum output voltage. The resistor can be calculated using the following equation.

$$R = \frac{12.35M}{V_{OUT-MAX} - 1.235}$$

### LAYOUT CONSIDERATIONS

When setting the output voltage, the resistor connected to the V<sub>SET</sub> pin should be as close as possible to the pin. No external capacitance should be added to this pin.

The RF<sub>IN</sub> feed line should be designed as a 50Ω trace and should be as short as possible to minimize feed line losses. The following table provides recommended dimensions for 50Ω feed lines (CPWG) for different circuit board configurations.

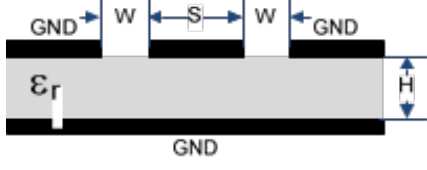
PCB Side View			
			
Material	Thickness (H)	Trace Width (S)	Spacing (W)
FR4 (ε <sub>r</sub> = 4.2)	62	50	9
FR4 (ε <sub>r</sub> = 4.2)	31	50	20

\*All dimensions are in mils.

The GND pins on each side of the RF<sub>IN</sub> pin should be connected to the PCB ground plane through a via located next to the pads under the receiver.

The D<sub>OUT</sub> pin can contain low-level analog voltage signals. If a long trace is connected to this pin, additional filtering capacitance next to the A/D converter may be required. Additional capacitance on this pin will increase the D<sub>SET</sub> delay time.

# P1110B

## 915 MHz RF Powerharvester® Receiver User Manual



### TYPICAL APPLICATION CIRCUIT

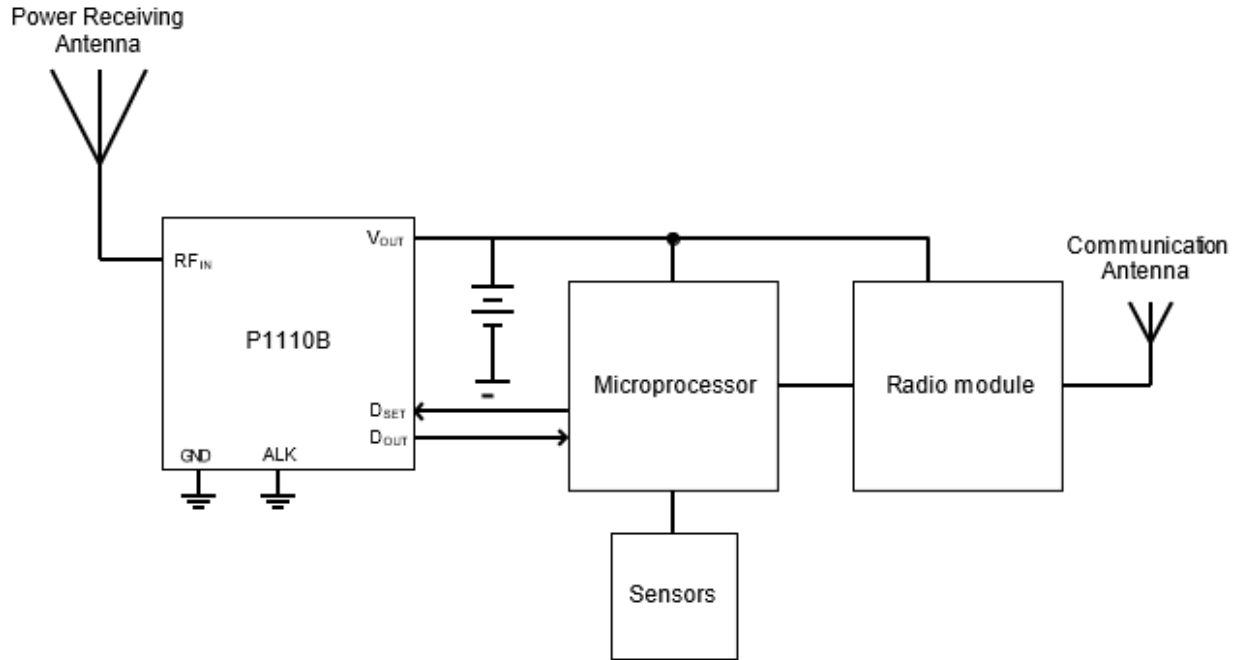

# P1110B

## 915 MHz RF Powerharvester® Receiver User Manual



### TYPICAL PERFORMANCE GRAPHS

T<sub>A</sub> = 25°C, unless otherwise noted.

**Powerharvester Efficiency  
vs. RF<sub>IN</sub>**

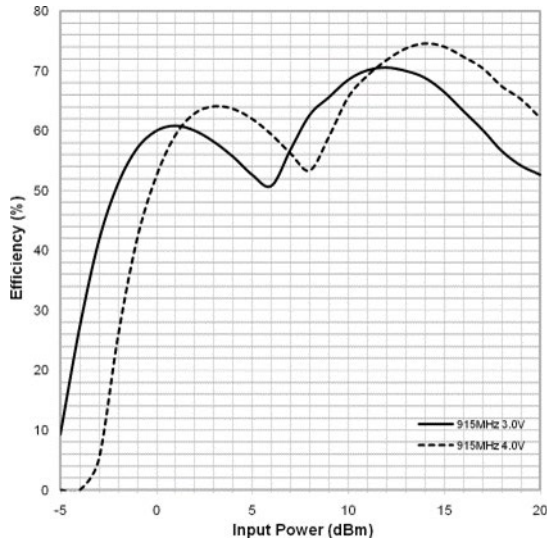

**Powerharvester Efficiency  
vs. RF<sub>IN</sub>**

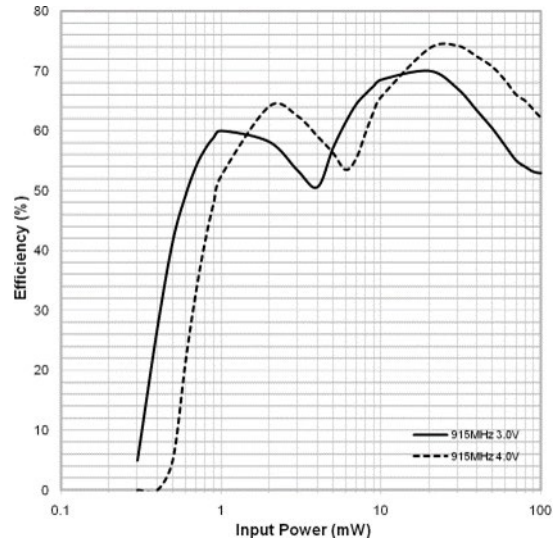

**Powerharvester Efficiency  
vs. Frequency**

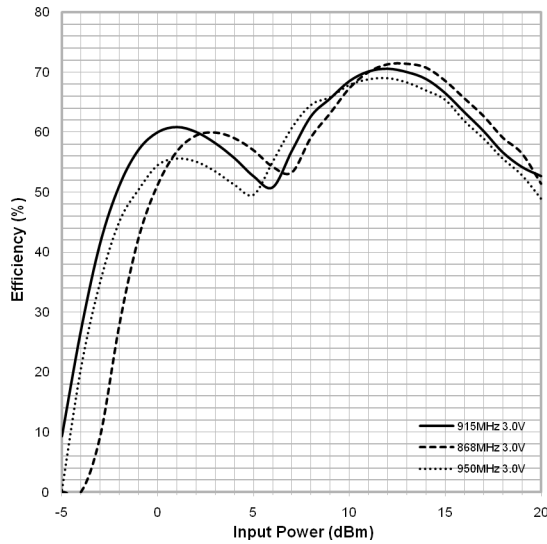

**Powerharvester Efficiency  
vs. Frequency**

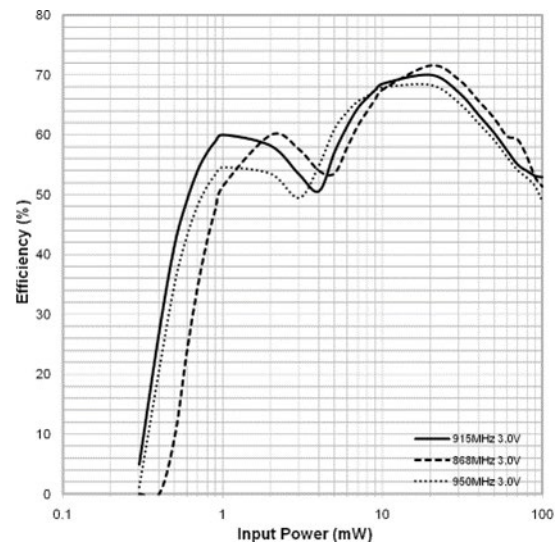

# P1110B

## 915 MHz RF Powerharvester® Receiver User Manual



### TYPICAL PERFORMANCE GRAPHS

T<sub>A</sub> = 25°C, unless otherwise noted.

#### Received Signal Strength Indicator vs. R<sub>FIN</sub> (dBm)

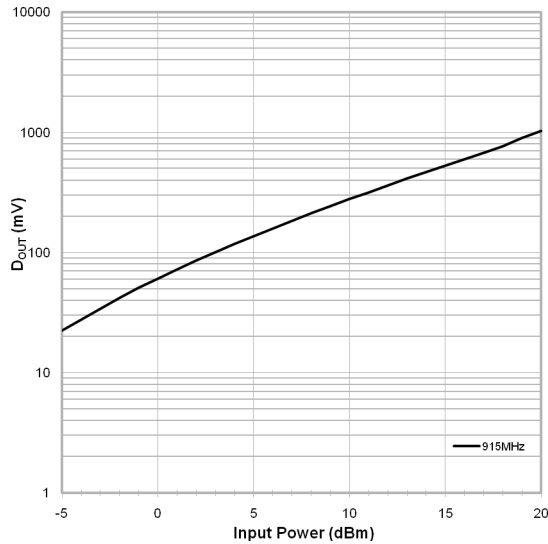

#### Received Signal Strength Indicator vs. R<sub>FIN</sub> (mW)

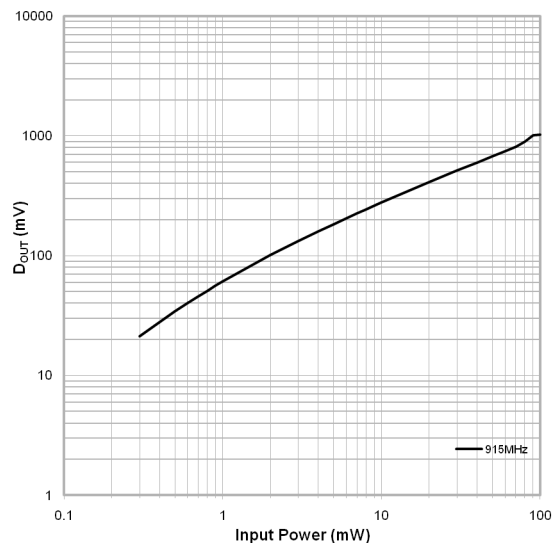

#### Charge Current vs. R<sub>FIN</sub> (dBm)

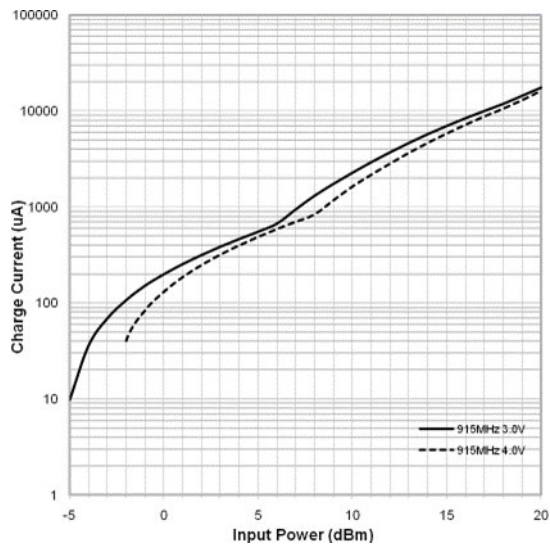

#### Charge Current vs. R<sub>FIN</sub> (mW)

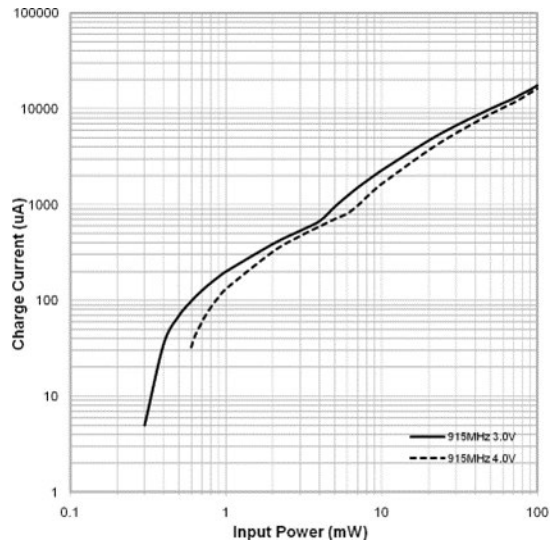

# P1110B

## 915 MHz RF Powerharvester® Receiver User Manual



### MECHANICAL SPECIFICATIONS

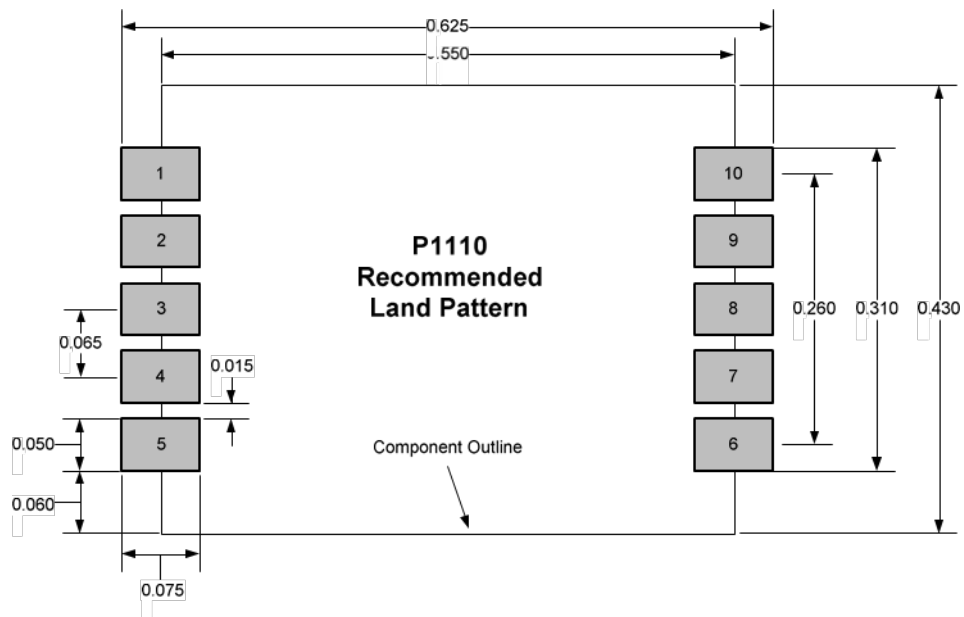
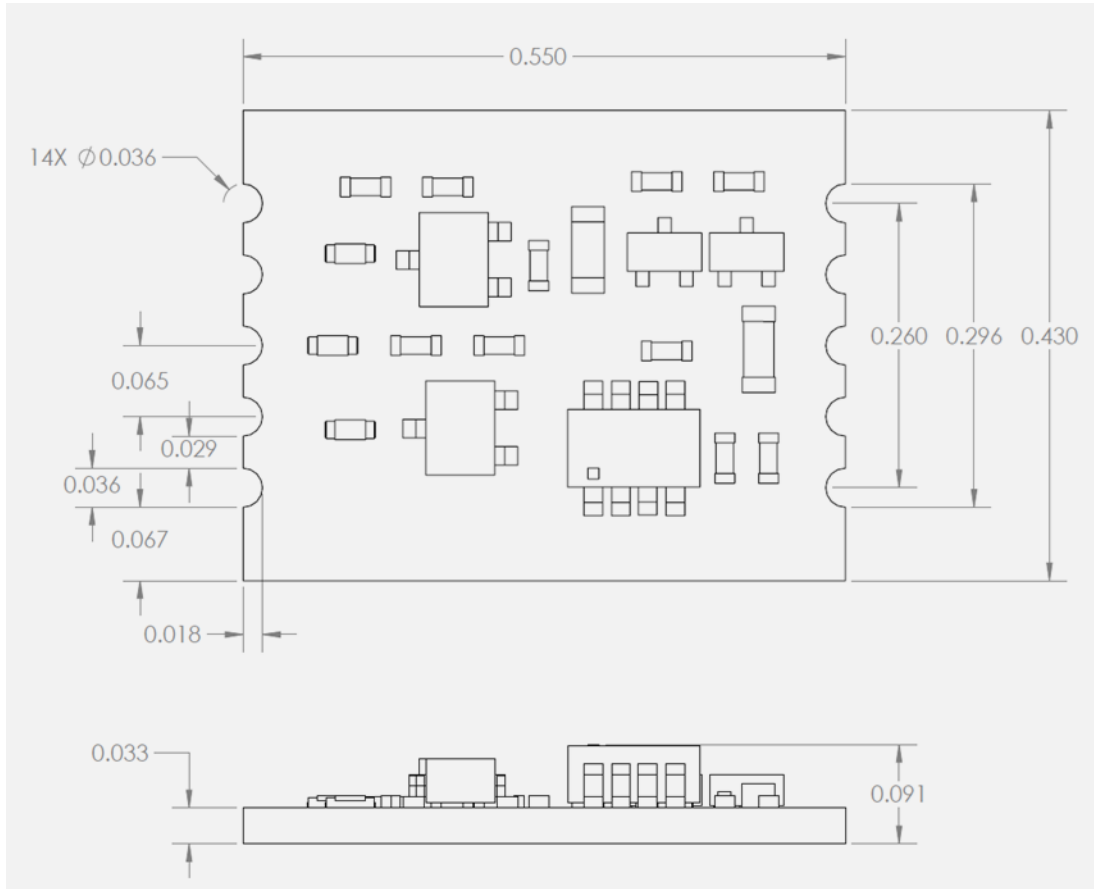



# P1110B

## 915 MHz RF Powerharvester® Receiver User Manual



### IMPORTANT NOTICES

Information furnished by Powercast Corporation (Powercast) is believed to be accurate and reliable. However, no responsibility is assumed by Powercast for its use, nor for any infringements of patents or other rights of third parties that may result from its use. Specifications are subject to change without notice.

No license is granted by implication or otherwise under any patent or patent rights of Powercast. Trademarks and registered trademarks are the property of their respective owners.

### CRITICAL APPLICATIONS DISCLAIMER

POWERCAST PRODUCTS (INCLUDING HARDWARE AND/OR SOFTWARE) ARE NOT DESIGNED OR INTENDED TO BE FAIL-SAFE, FAULT TOLERANT OR FOR USE IN ANY APPLICATION THAT COULD LEAD TO DEATH, PERSONAL INJURY OR SEVERE PROPERTY OR ENVIRONMENTAL DAMAGE (INDIVIDUALLY AND COLLECTIVELY, "CRITICAL APPLICATIONS"), SUCH AS LIFE-SUPPORT OR SAFETY DEVICES OR SYSTEMS, CLASS III MEDICAL DEVICES, NUCLEAR FACILITIES, APPLICATIONS THAT AFFECT CONTROL OF A VEHICLE OR AIRCRAFT, APPLICATIONS RELATED TO THE DEPLOYMENT OF AIRBAGS, OR ANY OTHER CRITICAL APPLICATIONS. CUSTOMER AGREES, PRIOR TO USING OR DISTRIBUTING ANY SYSTEMS THAT INCORPORATE POWERCAST PRODUCTS, TO THOROUGHLY TEST THE SAME FOR SAFETY PURPOSES. CUSTOMER ASSUMES THE SOLE RISK AND LIABILITY OF ANY USE OF POWERCAST PRODUCTS IN CRITICAL APPLICATIONS, SUBJECT ONLY TO APPLICABLE LAWS AND REGULATIONS GOVERNING LIMITATIONS ON PRODUCT LIABILITY.

Powercast warrants its products in accordance with Powercast's standard warranty available at [www.powercastco.com/terms-conditions](http://www.powercastco.com/terms-conditions)



### Powercast Corporation

620 Alpha Drive  
Pittsburgh, PA, USA 15238  
[www.powercastco.com](http://www.powercastco.com)  
[contact@powercastco.com](mailto:contact@powercastco.com)  
+1 (412)-455-5800